

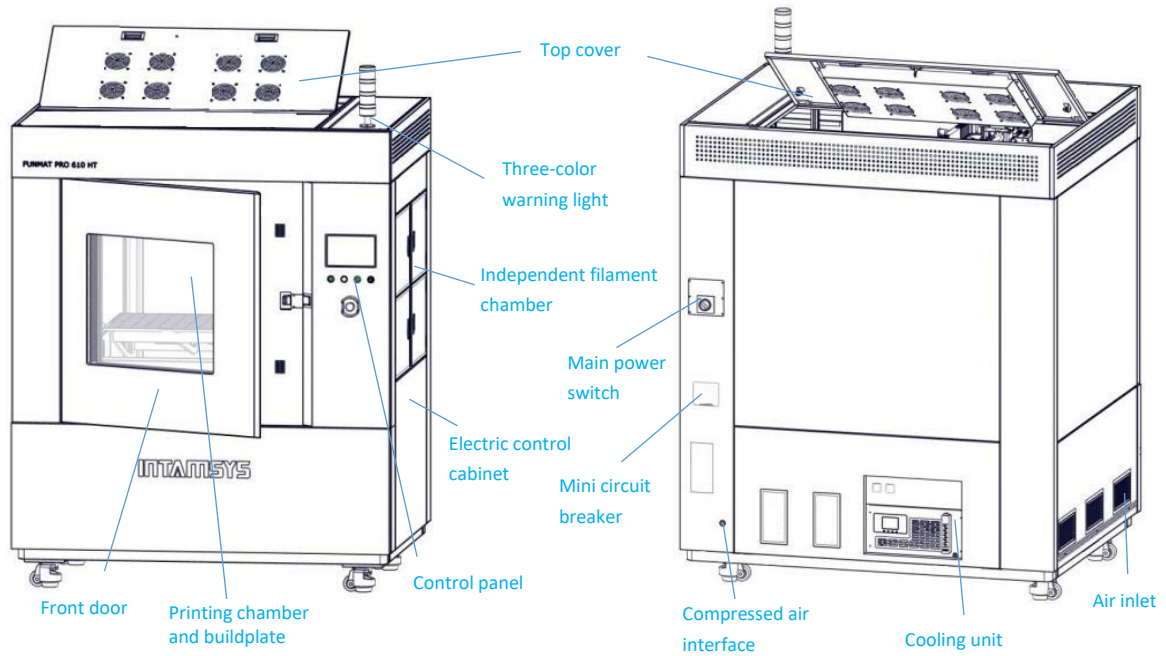

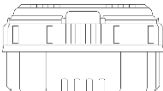











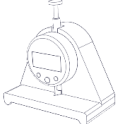
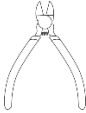





FUNMAT PRO 610HT Quick Start Guide

Printer Components

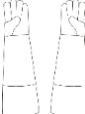

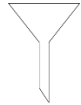
Packing List

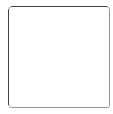
					
Tool Box x1	USB Cable (Print) x1	USB Cable ((Firmware upgrade) x1	Ethernet Cable x1	SD Card x1	SD Card Adapter x1
					
Digital Indicator x1	Cutting Plier x1	Cooper Brush x1	Tweezer x1	Removal Tool x1	Removal Tool x1
					
Allen Key Set x1	T-wrench x1	Socket Wrench x1	Leveling Card x1	Cleaning Needle x10	Cable Tie x30
					
High Temperature Resistance Glove x1	Drainage Hose x1	Funnel x1	Sprayed Steel Sheet x5	PC Sheet x20	Stainless Steel Sheet x1

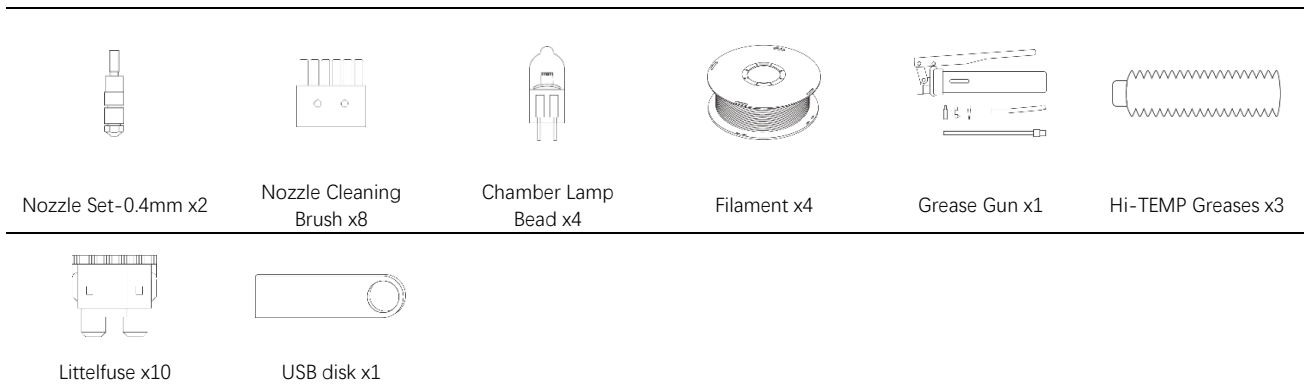

3D Printing Flowchart

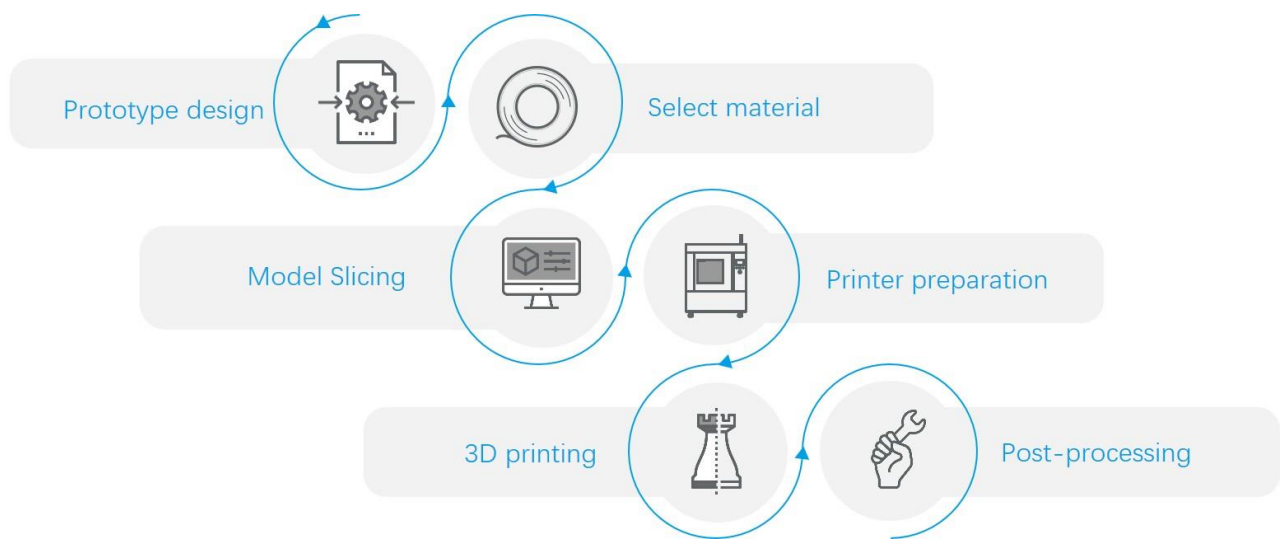

1 Prototype design

3D printing starts with prototyping design, additive manufacturing is different from other traditional methods. We recommend the concept of DfAM(Design for Additive Manufacturing), in order to make better use of additive manufacturing(complex structure, lightweight, fast verification, etc.).

The printable model file format should be .STL, .obj or .3mf.

2 Select material

Material selection is important for model and can affect the molding process and subsequent applications, and the table below is INTAMSYS recommended model material and support material matching.

Model material	PEEK	PEEK-CF	PEEK-GF	PEKK	Victrex AM™ 200	Ultem™1010	Ultem™9085
Support material	SP5000					SP5080	SP5030, SP5040
Model material	PPSU	PA6/66	PA6-CF	PLA	ABS	PC	ASA
Support material	SP5080	PVA, SP3040			HIPS		HIPS, SP3040

The filament needs to be dried before using. The water absorption of the material will significantly reduce the printing success rate, resulting in abnormal phenomena such as stringing during the printing process.

Preparation before printing: put the filament into the oven, dry it according to the preset temperature and time, then take it out for printing. The material will age at high temperature for a long time, which will affect the material performance.

PLA	ABS	ASA	PC	PA6/PA66	PA6-CF	PEEK
50°C/10h	80°C /4h	80°C /4h	80°C/12h	80°C/10h	80°C/10h	150°C/5h
PEEK-CF	PEEK-GF	PEKK	PEI 1010	PEI 9085	PPSU	PVA
150°C/5h	150°C/5h	130°C/6h	150°C/6h	130°C/6h	150°C/6h	80°C/12h
HIPS	SP3040	SP5000	SP5030	SP5040	SP5080	
80°C/4h	100°C/8h	100°C/12h	120°C/12h	120°C/12h	120°C/12h	

Note: For detailed printing process information of the filament, please referring to "FUNMAT PRO 610HT Printing Process Guide".

3 Model Slicing

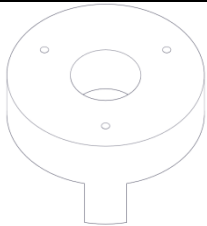

1. Model files of .stl, .obj, .3mf

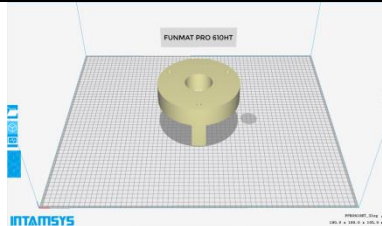

2. Import INTAMSUITE to set printing parameters.

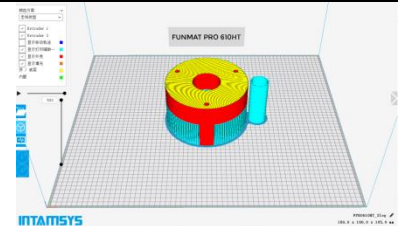

3. Complete model slicing and generate G-code file

The INTAMSUITE slicing software needs to be installed on the computer(Win OS) in advance. The software can set the printing parameters of the model and plan the slicing path, then generating a G-code file that can be run and processed by the 3D printer. For software usage and parameter setting, please referring to "INTAMSUITE User Manual".

INTAMSUITE Slicing software downloading: <https://www.intamsys.cn/software.html>

Note: After the G-code file is generated, it will prompt to estimate the material weight required for printing the model. The weight of the placed printing filament should be greater than the estimated weight. The placed printing filament should be heavier than the estimated.

4 Printer preparation

Equipment on/off and working mode selection

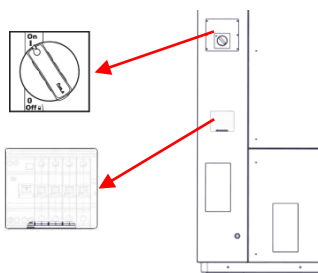

1. Move to the back of the printer, first push up the closing air switch, and then turn the rotary switch to **ON** to supply power to the device.

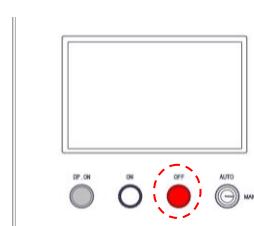

2. Move to the front of the printer, the **OFF** button on the control panel lights up red, indicating that power is supplied

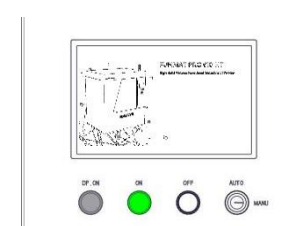

3. Press the **ON** button to power on, the **ON** lights up green and **OFF** light goes out, the operation screen enters the startup interface, about 30s later, the screen displays the welcome interface, and the device initialization is completed.

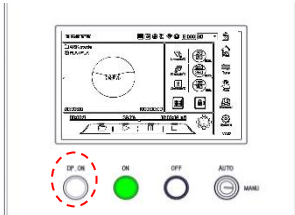
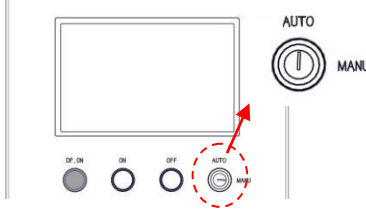
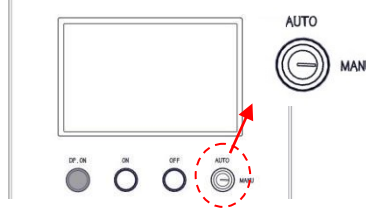
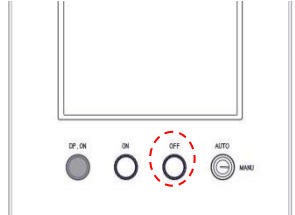
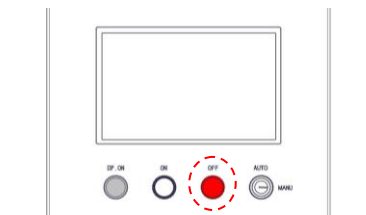
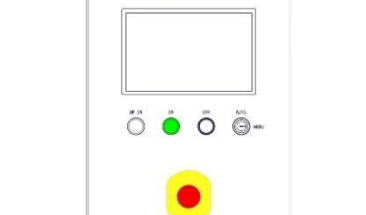
 <p>4. Press the white DP.ON button to power on the XYZ axis. The button lights up in white, the XYZ axis can move and the printer can be heated</p>	 <p>5. In the production state, it is recommended to enable the automatic (AUTO) mode to work, and the equipment provides high-level security protection</p>	 <p>6. Manual (MANU) mode is enabled during equipment maintenance, and the front door or top door can be opened through screen operation under any circumstances, it is not restricted by movement conditions and chamber temperature. Note: This mode must be operated by professionals with corresponding protective measures.</p>
 <p>7. If the device needs to be shut down, Press the OFF button, the screen prompts " Confirm to shut down the printer", click the screen YES icon to enter the shutdown process.</p>	 <p>8. After the shutdown is complete, the ON button with green light is off, and the OFF button is with red light is on.</p>	 <p>9. In case of emergency during the operation of the printer, press the red emergency stop button on the front of the equipment to make an emergency shutdown.</p>

Buildsheet Loading

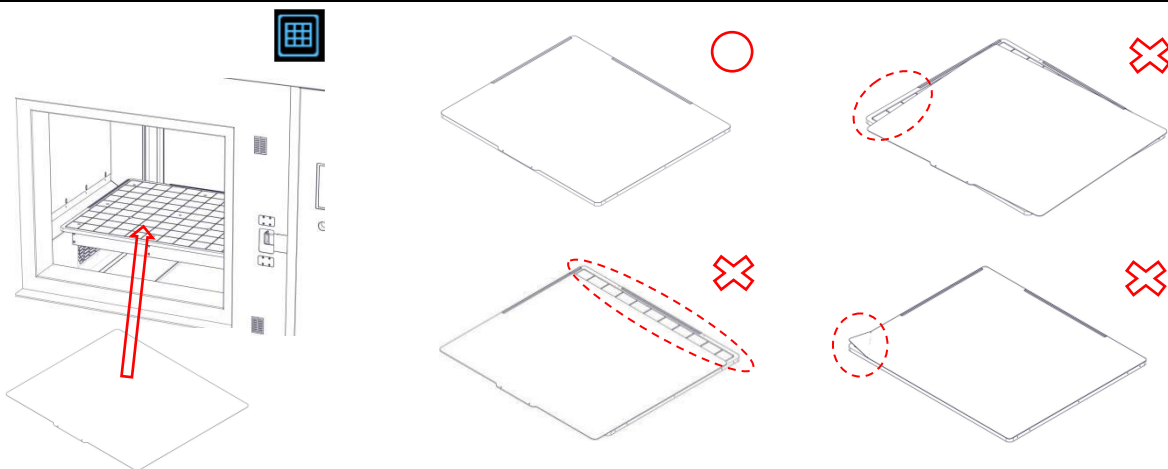

Clean the vacuum suction buildplate, select printing buildsheet corresponding to the material, load and align the buildsheet, and click the button on the screen to absorb the sheet. Improper placement of the sheet may cause the suction failure.

PC sheet	Sprayed steel sheet	Stainless steel sheet
 <p>PLA, ABS, PC, PA, PA-CF, PEEK, PEEK-CF, PEEK-GF, PVA, HIPS, SP3040, SP5000, Recommended chamber temp. ≤130°C</p>	 <p>Ultem9085, Ultem1010, PPSU, SP5030, SP5040, SP5080, Recommended chamber temp. ≤250°C</p>	 <p>Materials which need 250-300°C chamber temp.</p>

Note: The sprayed steel sheet and stainless steel sheet need to be heated in the chamber before vacuum adsorption, to ensure that the temperature of the buildplate is higher than 160 °C, and the vacuum adsorption can be performed normally after the stress is released.

Note: The buildsheet can be reused if it is not damaged. For the reused buildsheet, special attention should be paid to cleaning up the residual printing material.

Printing filaments loading

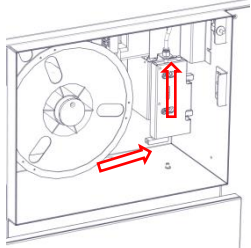
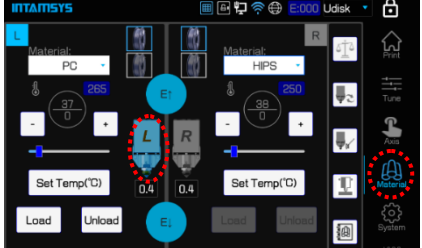
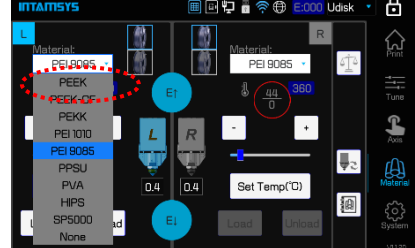
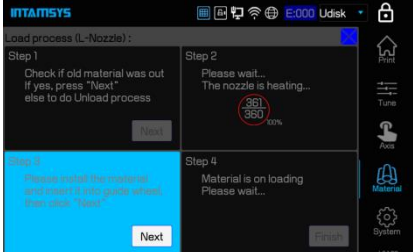
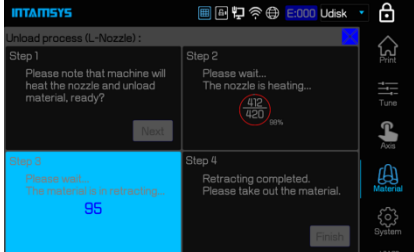
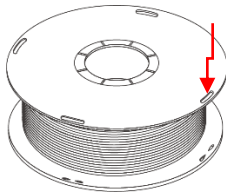
		
<p>1. Cut the end of the filament into a pointed shape, insert the material pan into the material shaft as shown, and the tip should extend beyond the gear bite, and avoid filaments loose and knot when feeding.</p>	<p>2. Click the Material icon and then the L icon to select the left nozzle. The icon will be highlighted when selected. (Same with the right nozzle)</p>	<p>3. Click the Drop-down menu to select the filament. Make sure that the filament you select is the same as the filament you want to load. Click Set Temp to heat the nozzle to the set temperature.</p>
		
<p>4. Click the Load button. There are 4 steps in total to load the filament. When the loading process is finished, click the Finish button. (If the filament is not extruded from the nozzle, click the E↓ button until the filament is extruded)</p>	<p>5. To unload the filaments, click the Unload button to unload the material and then follow the instructions on the screen.</p>	<p>6. Take out the material pan, and rewind the exiting filament onto the spool. To prevent filament from tangling, insert the end of the filament into the small hole on the side of the material pan.</p>

Sensor trigger distance calibration

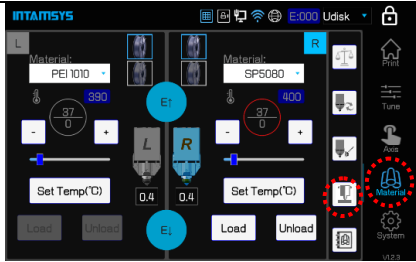

1. Click the **Material** icon, then click the  icon, start Sensor trigger distance calibration.

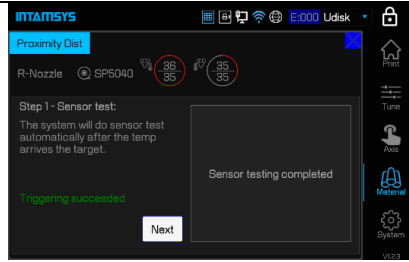

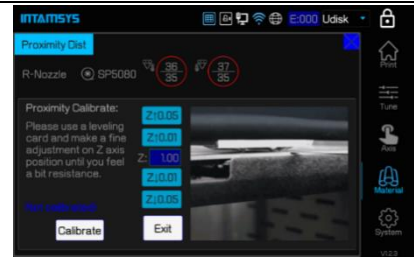

2. The printer performs the sensor trigger test automatically, once the test passes, the screen will display triggering succeeded, click the **Next** button.



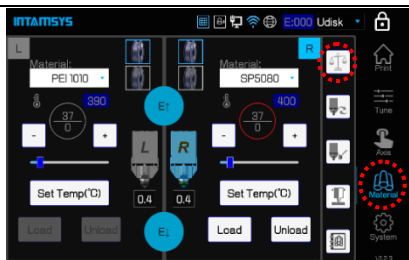

3. Use a leveling card(0.2mm thickness) and click "**Z↑0.05**" or "**Z↓0.05**" to make preliminary adjustments, and click "**Z↑0.01**" or "**Z↓0.01**" to make fine adjustments, the distance between the nozzle and the buildsheet just put in the card. Take out the card and click the **Calibrate** icon to complete the trigger distance calibration, click the **Exit** button to complete the general calibration.

Z-axis Deviation calibration

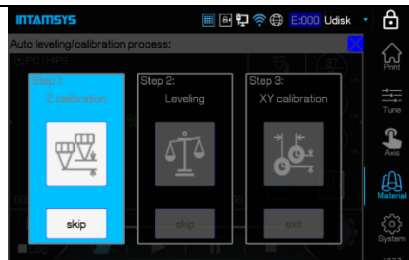

1. In the **Material** interface, click the  icon to enter the leveling interface



2. Click the **Z calibrate**  icon, and a prompt box will pop up to prompt you to clean the printing platform. After cleaning, click the **OK** button to formally enter the Z deviation calibration operation.

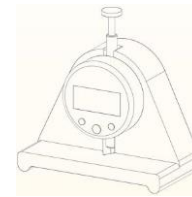

3. Take out the dial indicator and adjust it to mm, place it between the left nozzle and the buildplate, click the "**ZERO**" button on the dial indicator, you need to apply force in the horizontal direction to avoid the force in the vertical direction affecting the result.

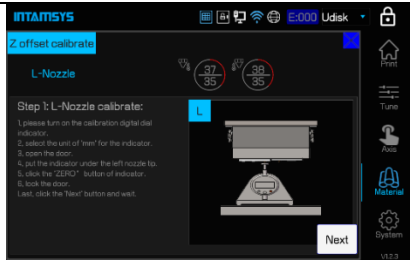

4. Calibrate the left nozzle first, and the nozzle will move to the specified position. Follow the instructions on the screen. Click the **Next** button to enter the next step. Follow the instructions on the screen to calibrate the right nozzle. After saving the deviation value, click the **Next** button to enter the next step.

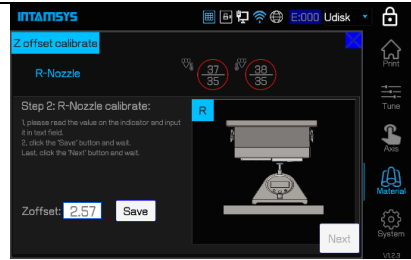

5. The buildplate will first descend and switch to the right nozzle, and then rise to make the right nozzle contact the digital indicator. The value displayed on the digital indicator is the Z deviation value of the left and right nozzles. Enter it into the dialog box on the screen and save it. You can click the **Recalibrate** button on the screen to repeat the calibration steps. If the two calibration results are consistent, the calibration value is reliable.

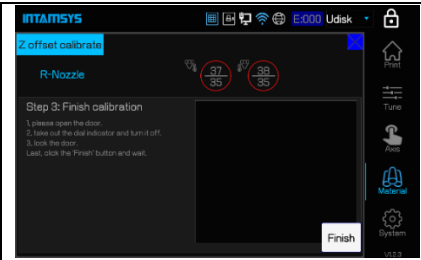

6. Follow the on-screen instructions and click the **Finish** button to end the calibration. After the operation is over, take out the digital indicator and close it.

Automatic leveling

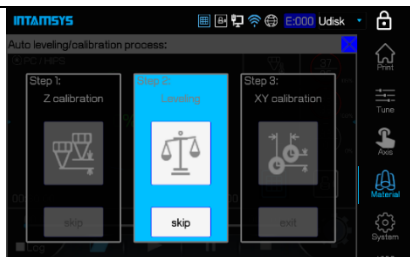

1. Measure 3 position points on the buildplate with the help of the leveling sensor on the nozzle, determine the relative position of the buildplate and the XY motion plane, and perform Z-direction compensation during the printing process. Click the **Leveling** icon, and a prompt box will pop up to remind you to clean the buildplate, chamber and nozzles to prevent interference with the leveling operation.

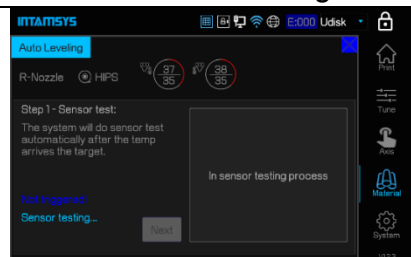

2. If the buildplate has been cleaned up, click the **OK** button to enter the automatic leveling operation. The printer will test automatically. After the sensor test is finished, the screen will display **Triggering succeeded**, click the **Next** button.

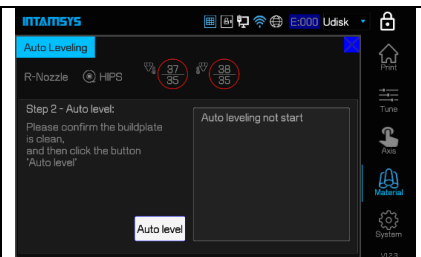

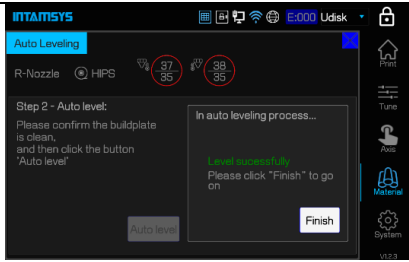

3. Click the **Auto level** button to prepare for the formal implementation of automatic leveling.

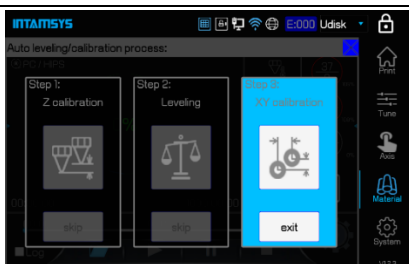

4. After the three-point automatic leveling is successful, click the **Finish** button, and the buildplate will move downward and upward to the origin of Z axis.

XY deviation calibration



1. Calibrate the deviation of the left and right nozzles in the X and Y directions, the deviation value is obtained by actually printing the calibration model. Click **XY Calibration**  to enter the sub-page, follow the prompts.

Note: Confirm whether the materials of the left and right nozzles have been loaded. Clean up the buildplate. Confirm the PC sheet has been placed on the buildplate.

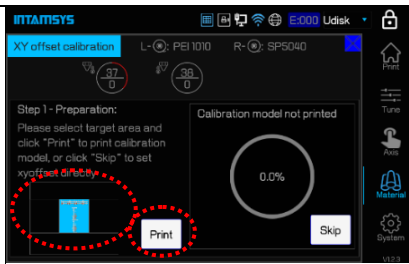

2. After selecting a suitable location, click the **Print** button to print the model ruler. Use the left and right nozzles to print the model ruler. when printing is completed, click the Next button and the nozzle will move away.

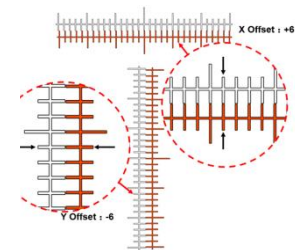

3. Take off the PC sheet with the printed reading ruler, check to obtain the X and Y deviation value.

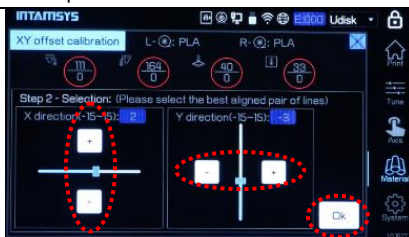

4. Click the **+/-** button to input the calibration value. Check the print model and set the appropriate compensation value, then click the **OK** button.

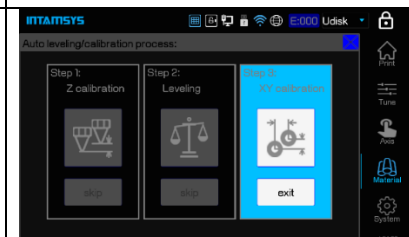

5. Finally, redo the print calibration, and click the **Finish** button to complete the calibration after the center line is fully aligned.

Note: If not aligned, set 15 in the corresponding direction, reprint and reset the offset value.

5 3D printing

G-code file import and print

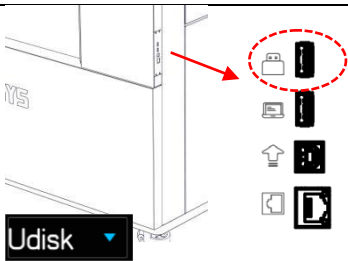

1-1. Insert a USB flash disk with printed files on the right side of the printer. Select the data source **Udisk** at the top right of the screen

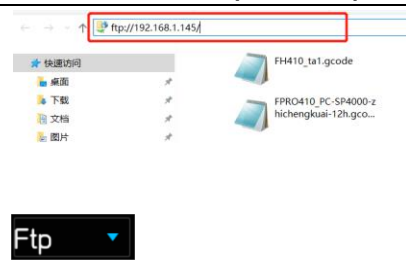

1-2. **Ftp** (network): enter the IP address of the printer in the address bar of the window folder on the computer, and transmit the G-code file to the printer through the network.

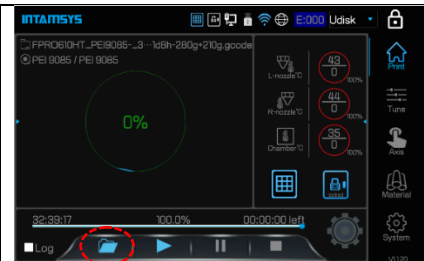

2. Click the  button on the screen to enter the print file selection interface.

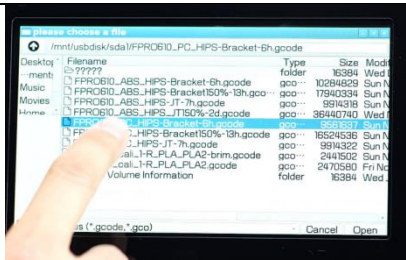



3. Select the file to be printed and click **Open** to confirm the opening;

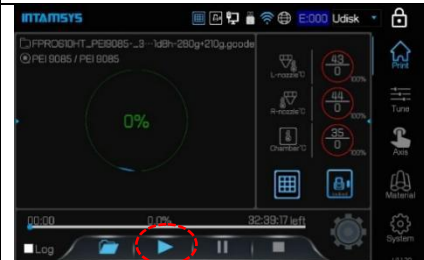

4. On the main interface, click the extension button on the left to set the printing preheat and maintaining time.

NOTE: Before printing, you can turn off the preheat or reduce the preheat time only if the chamber has been kept warm for a long time. Insufficient preheating time will lead to print failure.



5. Click  to start the print job. The right nozzle prints Raft and supporting materials, and the left nozzle prints the main material.



6. When the progress shows 100%, the printing is completed, after the temperature drops to a safe temperature, you can click  to open the door and take out the printed model.

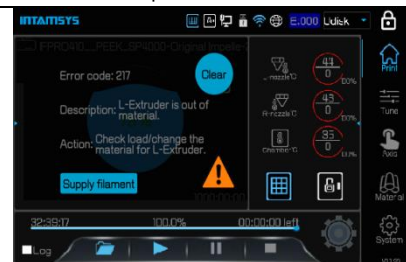

7. A warning is given in the display if problem occurs during printing. Depending on the severity of the warning, the alarm status button will turn yellow, orange, or red. Clicking the Alarm Status button will open a dialog indicating the reason and action for the alarm.

Note: You can also try remote printing function, set the Wifi and remote monitoring of the printer in advance, select the corresponding printer through INTAMSUITE, transfer the G-code to the printer and start printing remotely.

Take out print parts

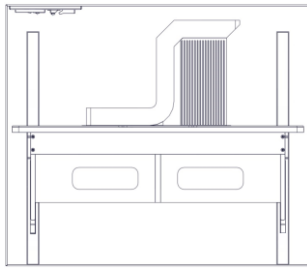

1. When printing finished, if you want to close the heat preservation, uncheck the **Maintaining** button, then the front door are unlocked; if you still want to keep the heat preservation, click  on the screen status bar to lock the front door.

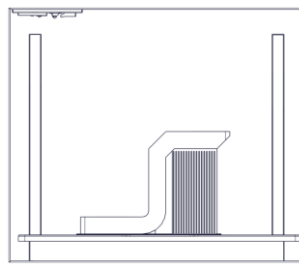

2. Click the **Axis**, then click the "Z ↓ -" button to make the buildplate move to the bottom, so as to facilitate the removal of the printing sheet.

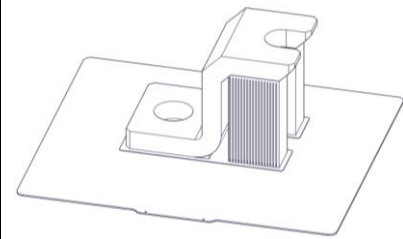

3. Click the  button on the screen to turn off the vacuum suction, then put on heat-resistant gloves and take out the buildsheet with printed part.

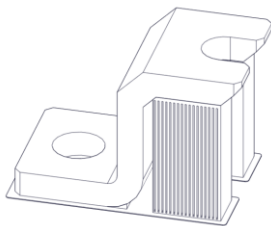

4. Carefully peel the part from the buildsheet with removal tools after the printed part cools down.

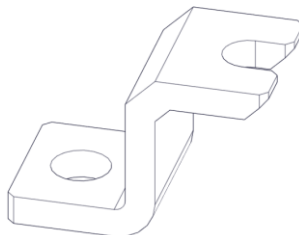

5. Remove the support material from the printed part.

6 Post-processing

Parts manufactured by FDM technology may have obvious layers after printing, some model parts need to remove the support, which will cause the support contact surface to be rough. The printed parts can be post-processed as needed, on the premise of ensuring the size, structure, mechanical properties, etc., the appearance of the sample is improved. Common post-processing processes include support material removal and surface treatment.

Support material removal	Surface treatment
Water-soluble support material: can be removed by high-pressure water gun, ultrasonic cleaner, agitator cleaner, etc.	Grinding: manual grinding, sandblasting, shot blasting, pearlescent treatment, etc. Chemical preparation polishing: alcohol atomization polishing, acetone fumigation polishing, etc.
Peelable support material: Removal with hand tools (e.g., diagonal pliers, files, scissors, etc.)	Repair: Filling soil, gluing, scraping putty Machining: turning, milling, drilling, etc. Back-end process of parts: painting, biting, electroplating, etc.

7 Common maintenance

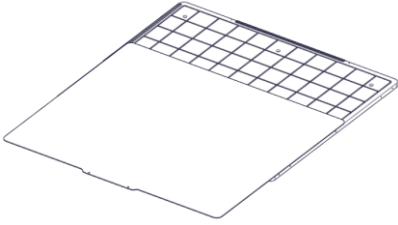
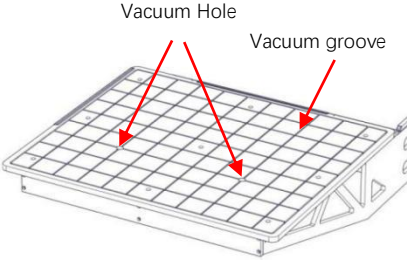
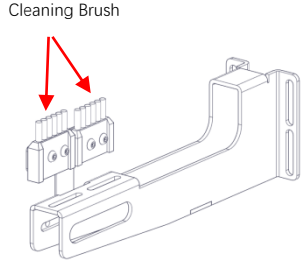
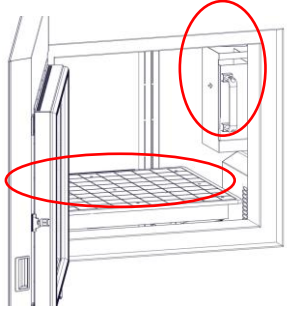
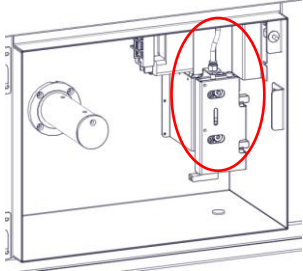
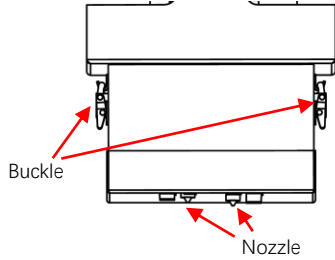
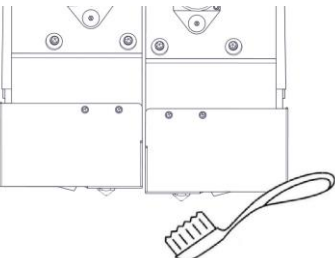
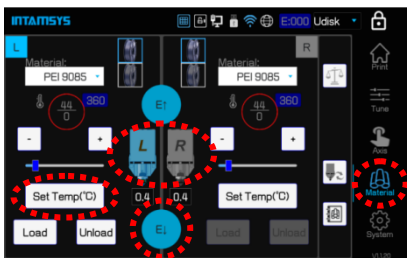
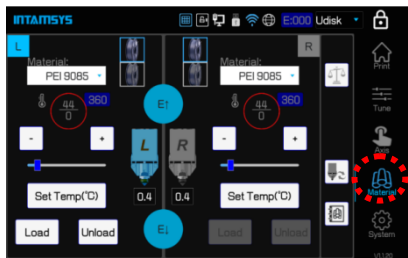
 <p>Clean the buildsheet: Remaining materials on the buildsheet or the materials dropped during the printing process should be cleaned in time before each printing to avoid affecting the next printing. Note: the buildsheet should not be excessively bent or the vacuum adsorption will be affected.</p>	 <p>Clean printing vacuum platform: Take the buildsheet out of the vacuum platform, and use a brush or vacuum cleaner to clean the vacuum platform, taking care to avoid the vacuum holes to prevent debris from clogging the vacuum tube.</p>	 <p>Cleaning nozzle brush: After one printing, the nozzle brush may stick to some materials. Please carefully clean up the materials and other sundries adhered to the nozzle brush. If more copper wire is found to be unable to remain upright, a new nozzle brush should be replaced.</p>
 <p>Cleaning the printing chamber: The materials left on the bottom plate or dropped during the printing process need to be cleaned up in time to avoid affecting the next printing. Use a vacuum cleaner and a removal tool to clean the waste and residue at the bottom of the chamber, side walls, etc.. Wipe with a cleaning cloth and alcohol if necessary,.</p>	 <p>Cleaning the filaments chamber: The frequent contact between the feed gear of the auxiliary wire feeding mechanism and the filament produces debris. Use a sharp needle to clean the debris at the gap of the gear, then use a vacuum cleaner to clean up the debris of the filament, and wipe the residual dust with a cleaning cloth and alcohol.</p>	 <p>If there is leakage of material, and through the gap into the housing or cover the nozzle in the housing clearance, it is necessary to remove the housing for cleaning. Hold the printhead cover with one hand, open the spring clasp with the other hand, and remove the printing head cover. According to the situation of material penetration, use tools to clean.</p>
		

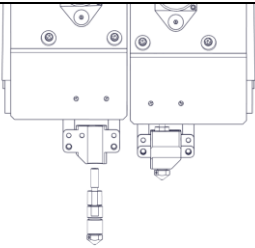
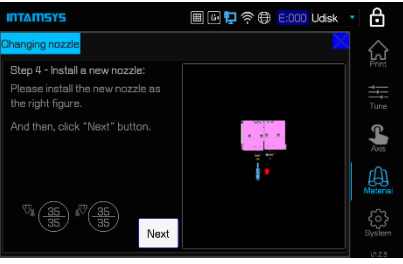
<p>Cleaning the printing nozzle: If the nozzle extrudes filament is too thin or the materials near the nozzle is clumped, and unable to extrude smoothly, use a brush or needle-nose pliers to peel off and clean the nozzle. If there is no obvious improvement, consider replacing the nozzle</p> <p>Note: To prevent high-temp. burns, need to wear heat-resistant gloves</p>	<p>Nozzle blockage test: Click the "Material" button, and then click the "Set Temp(°C)" button to heat the nozzle. After the temperature rises to the specified temperature, long press the button "E↓" and observe the extrusion condition of the nozzle. If the nozzle cannot extrude normally, use tools to dredge or replace the nozzle.</p>	<p>Nozzle disassembly #1: first remove the printhead cover, preheat the nozzle to the melting temperature of the material, and return of the material from the nozzle.</p>
 <p>Nozzle disassembly #2: Use a 2.5mm Allen wrench to loosen the screws on the front and side of the fan cover, remove the fan cover, and then loosen the 2 fixing screws on the heating block to take out the nozzle.</p>	 <p>New Nozzle Installation: Follow the prompts to replace the nozzle and reinstall the fan cover and printhead cover.</p> <p>Note: After replacing the nozzle, A recalibration and leveling operation is necessary</p>	



www.intamsys.com

Tel: +86 21-5846 5932



FOLLOW INTAMSYS ON

<p>Headquarters INTAMSYS Technology Co., Ltd. Support_APAC@intamsys.com Add: Building E11, No.3188 Xiupu Road, Pudong New District, Shanghai, P.R.China</p>	<p>Germany Branch INTAMSYS TECHNOLOGY GmbH Support_EMEA@intamsys.com Add : Zeppelinstr. 35, 73760 Ostfildern Deutschland</p>	<p>American Branch INTAMSYS Technology, Inc. Support_America@intamsys.com Add: 11479 Valley View Road Eden Prairie, MN 55344</p>
---	--	--

Copyright ©2021 INTAMSYS Technology. All rights reserved. The information at hand is provided as available at the time of printing, INTAMSYS reserves the right to change any information without updating this publication.